

LUMINAIRE PHOTOMETRIC TEST REPORT

Test:U:230.42V I:0.0896A P:18.207W PF:0.8819 Freq:50.00Hz Lamp Flux:2279.2x1 lm		
NAME: ASTRA ROUND	TYPE:CEILING LUMINAIRES	WEIGHT:
SPEC.:WW, BRIDGELUX	DIM.: Ø94 x 116	SERIAL No.:1329
MFR.: K-LITE	SUR.:	Shielding Angle:30°

DATA OF LAMP		PHOTOMETRIC DATA			
MODEL	KL-3684	Imax (cd)	4493	S/MH (C0/180)	0.52
NOMINAL POWER (W)	20	LOR (%)	69.7	S/MH (C90/270)	0.53
RATED VOLTAGE (V)	230	TOTAL FLUX (lm)	1588.8	η UP, DN (C0-180)	0.0, 33.7
NOMINAL FLUX (lm)	2279.2	CIE CLASS	DIRECT	η UP, DN (C180-360)	0.0, 36.0
LAMPS INSIDE	1	η up (%)	0.0	CIBSE SHR NOM	0.50
TEST VOLTAGE (V)	230	η down (%)	69.7	CIBSE SHR MAX	0.55

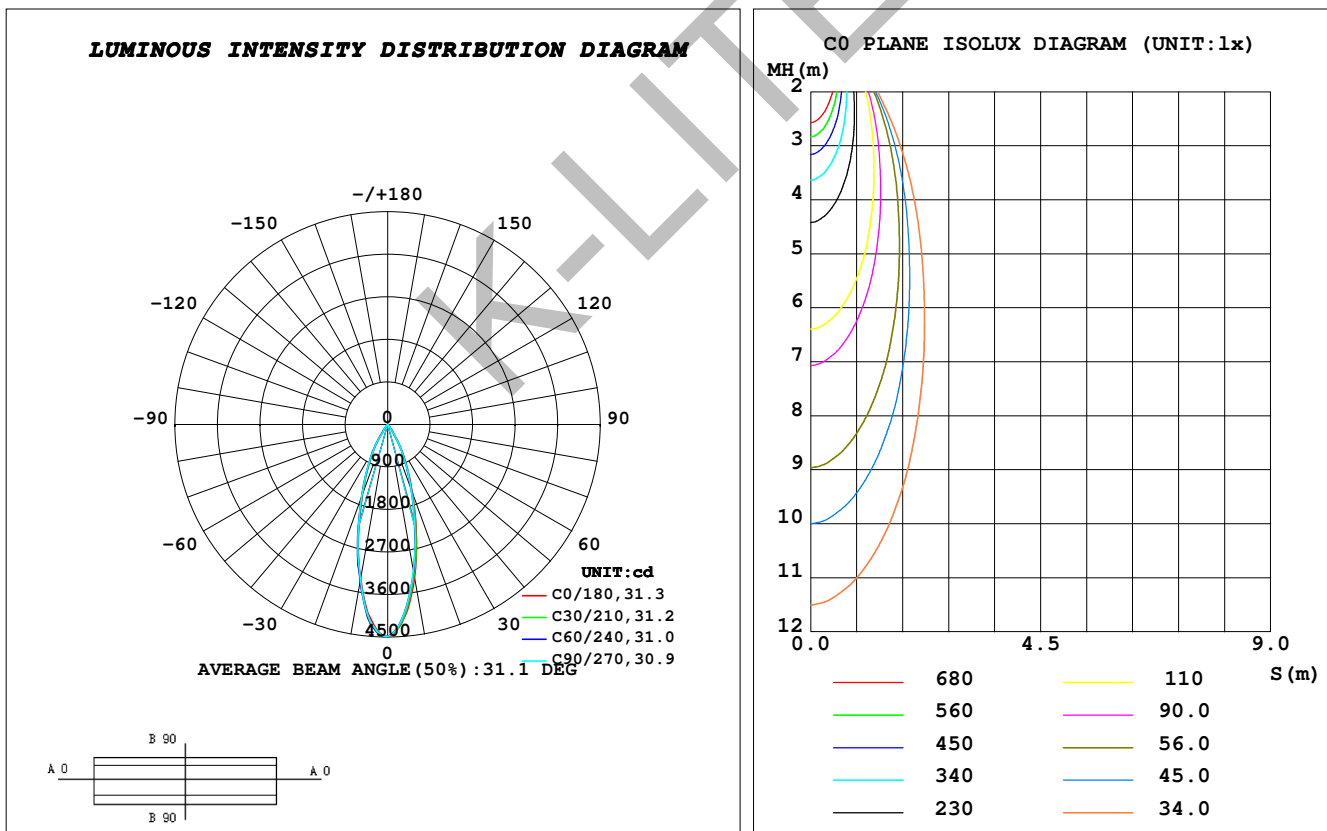

C Range: 0 - 360DEG
C Interval: 10.0DEG
Test Speed: HIGH
Temperature: 25.3DEG
Operators: K-LITE
Test Date: 25 May 2020

γ Range: 0 - 90DEG
γ Interval: 1.0DEG
Test System: EVERFINE GO-R5000_V2 SYSTEM V2.00.417
Humidity: 65.0%
Test Distance: 1.825m [K=1.0000]
Remarks: