

Up Down Lighters

Installation, Use and Maintenance Guidelines
(Indicative for all luminaires in this series)



Application

Wall mounted luminaire with shielded light source, designed for up / down lighting effects for illumination and design tasks in architecture. Various lamping options including LED offers durability and optimal light output with low power consumption.



Note : Technical amendments reserved

Light Source : LED. Varied wattage Options

Normal rated voltage for luminaire is 220-240V, 50Hz, single phase ac supply.

Installation Recommendation

- This product is suitable for Indoor & Outdoor application.
- Electronic equipment is sensitive to voltage surges. Hence it is recommended to install a stabilizer at source to ensure constant voltage power supply to all outdoor luminaires, for better performance and life span of the luminaire and to avoid risk of damage.
- Installation and maintenance of the luminaire should be carried out by qualified person only in accordance with good electrical practice and appropriate accessories.
- Use flexible cable of suitable rating and diameter with the right IP rated connectors.
- The IP rating of the connector between fixture and main cable must be equal to or greater than the IP rating of the Luminaire.
- It is very important to follow these instructions to enable the luminaire to be installed correctly. Failure to follow this will void all warranty on the product.
- Please retain installation guidelines for future reference.

Technical Specifications

- Luminaire made of extruded aluminium alloy (grade 6063) with die-cast aluminium components and non corrosive stainless steel 304 grade fasteners
- Clear tempered safety glass
- Silicon gasket
- Reflector made of pure anodised aluminium
- Mounting plate with fixing holes
- Cable entries for through-wiring of mains supply cable
- Earth connection
- Safety class I
- Protection class IP 65
- Dust tight and protection against water jets.

- CE - Conformity mark
- Finished with pure polyester powder coated colour - graphite grey / black

Light distribution

Luminaire photometric data / IES files for the light planning program DIALux can be downloaded in IES-format on the KLITE web page www.klite.in.

Safety

- For Safety, always ensure power supply is disconnected before regular maintenance, lamp replacement and accessory fitting.
- Installation and operation of this luminaire are subject to national safety regulations. The manufacturer is discharged from liability when damage is caused by improper use or installation.
- Any modification to this fixture without authorization will void all warranty and the persons responsible for the modification shall be considered as manufacturer.
- Observe precautions for handling LED module.
- Do not subject the product for voltage or current which is not rated for.
- Do not use lamps with higher wattage than indicated.
- Luminaire not suitable for direct mounting on normally flammable surfaces

Installation

The luminaire must only be operated with the complete protective cover.

- Undo screw at wall box.
- Remove mounting plate.
- Lead mains supply cable through the cable entry of the mounting plate.
- Fix mounting plate onto the mounting surface with suitable fixing material.
- It is absolutely essential to use the enclosure gasket. Make sure that gasket is in correct position, else the IP rating of the luminaire will be compromised.
- Use only flexible supply cables of suitable rating and diameter. Do not use hard cables or armoured cables (Hard cable could effect the IP rating of the product)
- Please ensure that the wires are connected to the right polarity [Phase, Neutral & Earth] and the luminaire must be earthed (Class I).
- Insert luminaire into the mounting plate and fix securely with non-corrosive stainless steel screws
- Lock and unlock the screws following an alternative sequence, tightening all screws evenly, ensuring 'O' ring in proper position while tightening.

Important Note

- LEDs are highly sensitive electronic components. Please avoid touching the light source directly, during installation.
- If fixture is supplied with integrated LED module, **Do Not Open** the lamp compartment for installation.

Cleaning and care

- After installation, the luminaire should first be cleaned.
- Building dust, residues from pressure-sensitive adhesives, paint splatter and rust film must be completely removed. Never use cleaning implements made of normal steel, steel brushes or steel wool because they cause extraneous rust to form.
- Cleaning agents containing hydrochloric acid and chlorides should never be used.
- We recommend cleaning the luminaires regularly.
- Do not use high pressure cleaners

Maintenance Recommendations

A scheduled maintenance program must be carried out on the Installation and fixtures regardless of the IP rating or application

- Disconnect the electrical installation before maintenance operation
- Open the luminaire. Remove the lamp and replace.

- Check the gasket, diffuser, seals are in good condition and replace, if necessary.
- Check that the screws are not loose on various components and that the cable gland is securely tight
- Ensure the luminaire is properly closed and clamped back into position after regular maintenance of lamp or control gear in order to maintain the IP rating of the fixture

Note:

The LED module contained in this luminaire shall only be replaced as per the manufacturer recommendation. For further informations, please contact your supplier.

Storage

If site is not ready for installation, store the material in proper warehouse facilities. K-Lite is not responsible for the damages caused due to the mishandling of material at site.



Important Note

To ensure proper installation, kindly translate / communicate the installation instructions to the local qualified electrician in their respective local language.



Please Recycle

The electronic components of this product should not be disposed via the normal waste system. To prevent possible harm to the environment and Human health please ensure that the product is recycled in an environmentally sound manner. Please contact your local collection facilities for more details

Customer Service

If Klite agrees to receive back some fixtures for Lab Testing and further analysis please ensure that the fixtures shipped should NOT BE DISASSEMBLED. Disconnect the power line and ship the product as is unless otherwise specified.

Please contact customer care@klite.in for more information.

Up Down Lighters

Installation Guidelines

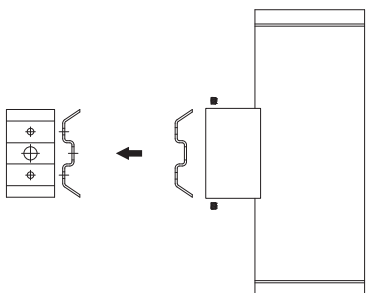

- Undo screw at wall box.
- Remove mounting plate.

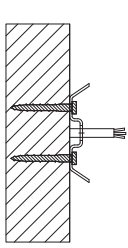

- Lead mains supply cable through the cable entry of the mounting plate.
- Fix mounting plate onto the mounting surface with suitable fixing material.

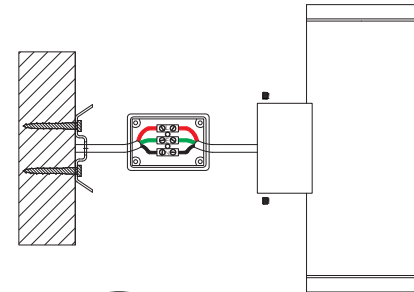

L - Phase
E - Earth
N - Neutral

OK

Please ensure that the wires are connected to the right polarity [Phase, Neutral & Earth] and the luminaire must be earthed (Class I)

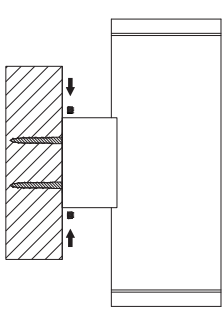

- For Integrated LED version do not open lamp compartment during installation.
- Insert luminaire into the mounting plate and fix securely with non-corrosive stainless steel screws.

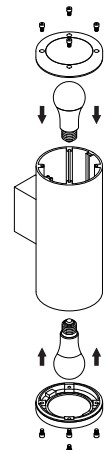

- Insert lamp not exceeding the recommended wattage and tighten the screws following an alternative sequence.
- It is absolutely essential to use the enclosure gasket. Make sure that gasket is in correct position, else the IP rating of the luminaire will be compromised.

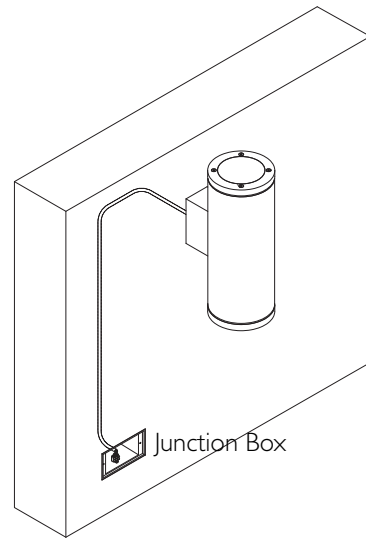

Junction Box

⚠ Always ensure that the Junction box is below the luminaire during Installation

How to Install your outdoor luminaire correctly with connectors



Water infiltration is one of the biggest reasons of damage to outdoors fixtures. The main reason being no proper water proof connectors being used during installation.

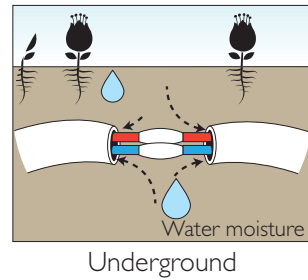
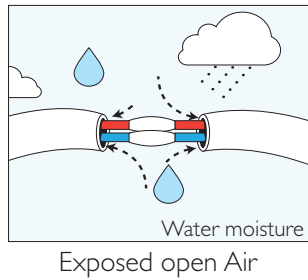

Why use the water - proof connector ?

When the fixture is turned on, the inside temperature will increase as the operating time goes. Conversely when the lamp stops working, the temperature will drop slowly. This phenomenon will cause "The siphon effect". Thermal expansion and contraction makes the inside and outside air pressure different. The air which includes water vapour will infiltrate to the housing through the wire entry as soon as the internal air pressure is lesser than the external pressure. The infiltration is caused by several incorrect connections like the picture below. This water vapour will then become droplets of water that will be seen inside the fixture.

Incorrect Installation

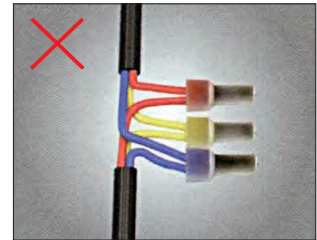
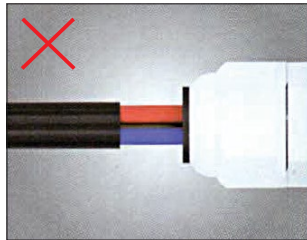

When the wire is connected into the fixture through cable gland, the cable must be more than 10mm inside. Please refer to the images below.

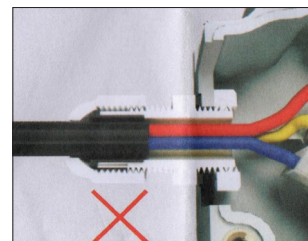
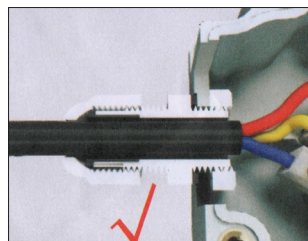

The best and easiest ways to prevent the water filtration are by IP rated connectors

We recommend using the water-proof connectors as shown below for all outdoor fixtures. Installers should prepare the appropriate main cables of suitable rating and diameter with the right IP rated connectors.

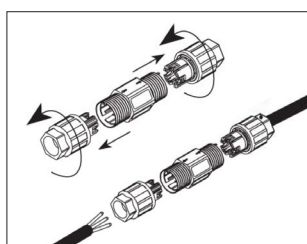

One input & two output

